

Beck.

The adjustable
pressure switches Prescal®.



Pressure switch 901 Prescal®

with adjustable setting



Application

Adjustable pressure switch monitoring overpressure, vacuum or differential pressure of liquid and gaseous . also aggressive . media

The switching pressure can be adjusted without a pressure gauge using a scaled adjustment knob.

Temperature range

Ambient temperature from . 20°C to +85°C
 Temperature of media up to 85°C or 130°C depending on material of pressure connection and diaphragm

Diaphragm material

Depending on media NBR, Silicone, FKM (Viton®), EPDM. For 901.8x Silicone, others upon request

Electrical rating

Standard version	max. 6 (1.5) A / 250 VAC
	max. 10 (2) A / 250VAC
	max. 2 A / 24VDC
Low-voltage version	max. 100 mA / 24 VAC
	max. 30 mA / 24VDC

Electrical connection

Tab terminal 6.3 mm x 0.8 mm in accordance with DIN 46244

Life

Mechanically more than 10⁶ cycles

Mounting position

Mounting in any position, to be specified for settings below 100 mbar

Arrangement of contacts

für 901.6x, 901.8x, 901.9x

nur für 901.7x

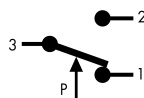

Damping

Restrictors alternatively with 0.3/0.5/0.8 mm diameter

Protection

IP00 without protection cap
 IP44 / IP54 / IP65 depending on the used protection cap

Protection class

Protection class II is only met by using a protection cap from our accessories program.

The pressure switch without protection cap is provided for installation in equipment. The construction of the equipment and the type of installation determine the protection class.

Conformity

EU Low Voltage Directive
 EU RoHS Directive
 EU ATEX Directive

Warning

Read instructions before use. This regulating and control unit must be installed in compliance with the applicable regulations.

Accessories

Various mounting brackets and protection caps with IP 44, IP 54 and IP 65

Pressure connection

Type	Tube connection			Threaded connection			
	5.0 mm	6.5 mm	10.0 mm	M10x1	G1/8	G1/4	G1/2
901.61 - 65	PA	PA, PPS	PA, PPS	PA, PVDF CuZn40, V ₂ A	PA, PVDF CuZn40, V ₂ A	CuZn40, V ₂ A	CuZn40
901.66 - 68				CuZn40, V ₂ A	CuZn40, V ₂ A	CuZn40, V ₂ A	CuZn40
901.71 - 76	PA	PA, PPS	PA, PPS	PA, PVDF CuZn40, V ₂ A	PA, PVDF CuZn40, V ₂ A	CuZn40, V ₂ A	
901.77 - 78				CuZn40, V ₂ A	CuZn40, V ₂ A	CuZn40, V ₂ A	CuZn40
901.8x		PA					
901.91 - 93				CuZn40	CuZn40, V ₂ A	CuZn40, V ₂ A	

PA = polyamide, PVDF = polyvinylidene fluoride, PPS = polyphenylene sulfide, CuZn40 = brass, V₂A = stainless steel

For temperature above 85° C metal or PPS pressure connection is required. Upon request pressure connections of other sizes, other plastics or brass nickel-plated are available.

Viton® is a registered trademark of DuPont Dow Elastomers.

Prescal® is a registered trademark of Beck GmbH Druckkontrolltechnik.

Overpressure range

Type	Adjustment range for trip pressure		Switching differential	Maximum positive working pressure standard/extended	Maximum negative working pressure standard/extended
	from	to			
901.61	5 mbar	20 mbar	3 mbar	0.5 / 4 bar	- / - 1 bar
901.62	10 mbar	50 mbar	5 mbar	0.5 / 4 bar	- / - 1 bar
901.63	25 mbar	100 mbar	10 mbar	0.5 / 4 bar	- / - 1 bar
901.64	50 mbar	250 mbar	20 mbar	1 / 4 bar	- / - 1 bar
901.65	100 mbar	500 mbar	50 mbar	1 / 4 bar	- / - 1 bar
901.66	250 mbar	1,000 mbar	150 mbar	10 bar	- 1 bar
901.67	500 mbar	1,500 mbar	250 mbar	10 bar	- 1 bar
901.68	1,000 mbar	3,000 mbar	500 mbar	10 bar	- 1 bar
901.91	1.0 bar	6.0 bar	0.5 . 2.0 bar	25 bar	- 1 bar
901.92	4.0 bar	9.0 bar	0.5 . 2.0 bar	25 bar	- 1 bar
901.93	7.0 bar	12.0 bar	0.5 . 2.0 bar	25 bar	- 1 bar

Vacuum range

901.71	-5 mbar	- 20 mbar	3 mbar	0.5 / 4 bar	- 1 bar
901.72	-10 mbar	- 50 mbar	5 mbar	0.5 / 4 bar	- 1 bar
901.73	-25 mbar	-100 mbar	10 mbar	0.5 / 4 bar	- 1 bar
901.74	-50 mbar	-125 mbar	20 mbar	0.5 / 4 bar	- 1 bar
901.75	-75 mbar	-200 mbar	25 mbar	1 / 4 bar	- 1 bar
901.76	-100 mbar	-300 mbar	30 mbar	1 / 4 bar	- 1 bar
901.77	-200 mbar	-500 mbar	75 mbar	1 / 4 bar	- 1 bar
901.78	-300 mbar	-700 mbar	75 mbar	1 / 4 bar	- 1 bar

Differential pressure range

901.81	5 mbar	20 mbar	3 mbar	100 mbar	-100 mbar
901.82	10 mbar	50 mbar	5 mbar	100 mbar	-100 mbar

Dimensional Drawings

901.6x/7x

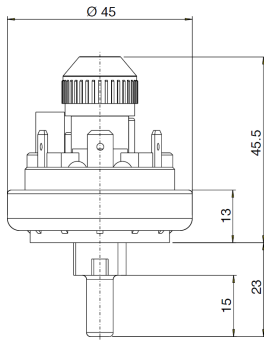

901.8x

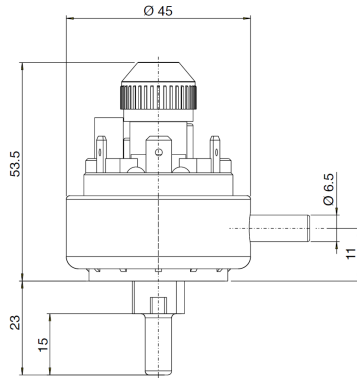

**Protection caps
6329 IP44**

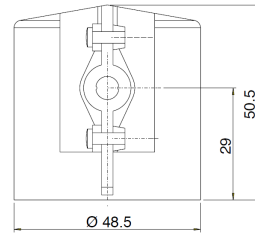

901.6x/7x

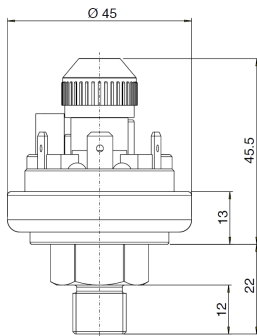

901.9x

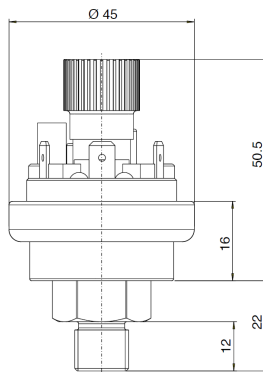

6365 IP54

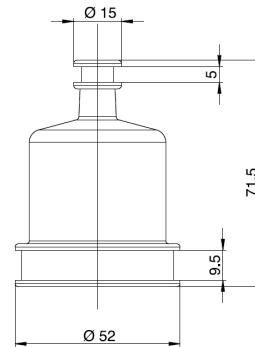

6371 IP54 / 6372 IP65

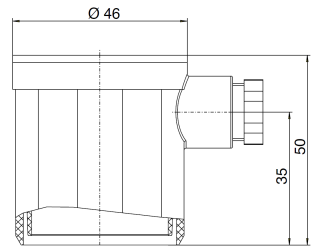

Mounting brackets

6403

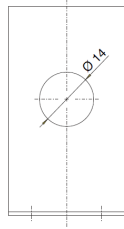

6404

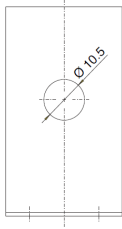

6405

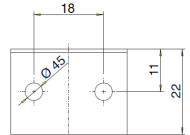
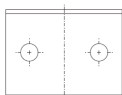
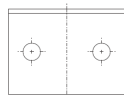
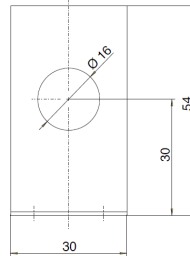

6374 IP54 / 6375 IP65

