



Beck Sensortechnik GmbH
Ferdinand-Steinbeis-Straße 4
71144 Steinenbronn

Operating Instructions





1	General instructions	3
1.1	Safety instructions	3
1.1.1	General safety instructions	3
1.1.2	Safety instructions for potentially explosive areas	4
1.1.3	Notes on environmental protection	4
2	Correct purpose of use	5
2.1	Application area	5
2.2	CE conformity	5
3	Storage and transportation	6
3.1	Packaging	6
3.2	Storage and transportation conditions	6
4	Installation	6
4.1	Installation	7
4.2	Connection	7
4.2.1	Pressure connections	7
4.2.2	Electrical connections	7
5	Start-up	9
5.1	Parameterisation	9
6	Maintenance / service	10
6.1	Time intervals	10
6.2	Troubleshooting	10
7	Repairs	11
8	Dismantling	11
8.1	Disposal	11
9	Appendix	12
9.1	Technical data and dimensioned drawing	12
9.2	Dimensioned drawings and accessories	14
9.3	Declaration of Conformity	15
9.4	EU-Type Examination Certificate	16
9.5	Proof of compliance with explosion protection regulations	19

Telephone +49 7157 52 87-0
Telefax +49 7157 52 87-83
E-Mail sales@beck-sensors.com
Internet https://www.beck-sensors.com
VAT-no. DE339027502

Bank Accounts
Kreissparkasse Esslingen-Nürtingen (BLZ 611 500 20) 57 011 970
S.W.I.F.T. ESSLDE66 IBAN: DE33 6115 0020 0057 0119 70
Commerzbank Stuttgart (BLZ 600 400 71) 876 179 300
S.W.I.F.T. COBADEFF600 IBAN: DE70 6004 0071 0876 1793 00
Landesbank Baden-Württemberg (BLZ 600 501 01) 2 214 306
S.W.I.F.T. SOLADEST IBAN: DE36 6005 0101 0002 2143 06
UniCredit Bank - HypoVereinsbank Stuttgart (BLZ 600 202 90) 388 773 332
S.W.I.F.T. HYVEDEMM473 IBAN: DE66 6002 0290 0388 7733 32

Location: Steinenbronn
Amtsgericht Böblingen HRB 776485
Managing Directors: Rainer Beck,
Hans-Peter Funk



1 General Instructions

These operating instructions contain all of the information that is required for an efficient start-up and safe operation of **Model 930...EX** pressure switches.

- Please read these operating instructions before carrying out installations, start-ups, maintenance and repairs.
- Please ensure that these operating instructions are available at all times.
- Please follow the applicable instructions and safety regulations.
- All of the work that is described in these operating instructions must be carried out by qualified and authorised experts.
- In order to avoid problems, the prescribed maintenance must be carried out at regular intervals by appropriately trained personnel.

Symbols used

The meanings of the symbols that are used are as follows:

- Useful, important additional information.
- Dangers and safety instructions. *Important – please read!*
Failure to comply with these instructions can have a detrimental effect on persons and the operation of the equipment.
- Important instructions for use in potentially explosive areas.
Danger – *please read!*



1.1 Safety Instructions

1.1.1 General safety instructions

- Please follow the applicable
 - Instructions and system-specific regulations (e.g. installation standards etc.)
 - Safety regulations and accident prevention regulations
- All work must be carried out by authorised and qualified personnel. These qualifications and authorisations include:
 - Training, experience and knowledge of the regulations, standards
 - Only personnel with appropriate product knowledge must carry out start-ups and maintenance
 - All repairs must be carried out by personnel who have been authorised to do so by the manufacturer
- Only original parts must be used
- Ignoring these operating instructions and making modifications to the equipment are not permitted and can lead to hazardous situations



1.1.2 Safety instructions for potentially explosive areas



- The 930..EX pressure switch is suitable for use in areas where there is a *risk of gas or dust explosion*
- Please follow the applicable
 - Instructions and system-specific regulations
- The labelling of the product must point out that important explosion protection characteristics must be adhered to during use.
 - G = Gas; D = Dust
 - Device category 1, 2, 3 or Equipment Protection Level EPL in the 3 zonal areas
 - Gas parameters: temperature class (T1...T6), explosion group (A, B, C)
 - Dust parameters: Explosion group (IIIA, B: non-conductive; IIIC: conductive);
 - Surface temperature, glow and ignition temperature
- When work is being performed such as installation, making electrical connections, making repairs or opening the housing, it must be ensured that
 - *no potentially explosive atmosphere is present*
 - *no electrical voltage is present*
 - *unintentional activation is ruled out*
- Dust deposits must be avoided (installation location, protection, cleaning etc.) in order to prevent dangerous surface temperature increases
- For the installation procedure it is necessary to take care that no electrostatic charging will be done (no high volume flow, cleaning only with damp cloth,...)
- It must be ensured that all technical and organisational protective measures are complied with and that the operation and effectiveness thereof is checked
- No modifications must be made to the equipment, since they may lead to a risk of explosion (ignition)
- The specifications of the EU-Type Examination Certificate are binding and must be complied with
- If the number of the EU-Type Examination Certificate is followed by an "X", special conditions or deviations from the standard conditions exist
- Installation, start-ups and repeated testing may only be carried out by appropriately qualified personnel
- The operator must issue a release for work before any activity (installation etc.) is carried out in potentially explosive areas.

1.1.3 Notes on environmental protection

Please help to protect the environment. Please pay attention to the environmental notes in these operating instructions:

- Chapter 3.1 "Storage": Handling of packaging materials
- Chapter 8.1 "Disposal": with regard to the product and its components

2 Correct Purpose of Use

2.1 Application area

➤ Purpose of use

The adjustable differential pressure switches have the following main purpose

- Monitoring air flow in ventilation shafts for adequate
 - ✓ Dilution of gasses that are hazardous to health or potentially explosive
 - ✓ Air supply (fresh air) and/or exhaust air – extraction of “bad” air
- Operational monitoring by monitoring the air flow of
 - ✓ (Air) filters
 - ✓ Air and fire safety flaps
 - ✓ Fans, ventilators
 - ✓ Leak tightness of closed systems
- Liquid level monitoring

The media that are being monitored occur in the following different phases

- *Gaseous* (main application)
 - ✓ Potentially explosive gasses and dust (natural gas, bio-gas, solvents etc.)
- *Liquid*
 - ✓ Flammable liquids (petrol, solvent etc.)

➤ Use in zones in potentially explosive areas

Pressure switches are used to monitor the pressure difference in areas of closed systems where there is a risk of gas explosion.



- The device may be used in areas where there is a risk of gas or dust explosion
- Two separate zonal areas can be connected via pressure connections P1 and P2 (areas 1 and 2)
- Zone 1,2 or zone 21,22 may apply to the pressure connections (areas 1 and 2)
- The surroundings (area 3) can be zone 1,2 or zone 21,22

Area-1	Area-2	Surrounding Area-3	Equipment category Equipment Protection Level EPL
Zone 1,2	Zone 1,2	Zone 1,2	2G Gb
Zone 21,22	Zone 21,22	Zone 21,22	2D Db

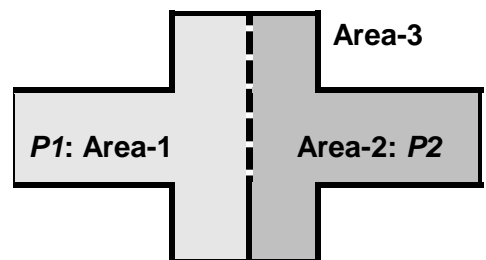

2.2 CE Conformity

The product complies with the following European directives:

- Explosion protection directive
- RoHS directive

Other information and verification can be found in the

- Conformity declaration (see Chapter 9.3)



3 Storage and Transportation

3.1 Packaging

The equipment is protected by packaging. The packaging is environmentally compatible and recyclable. The following main materials are used:

- Cardboard
- PE foam or PE film



Please use appropriate recycling companies to dispose of the packaging

3.2 Storage and Transportation Conditions

The following points must be observed in order to prevent damage:

- Avoid severe mechanical stress caused by throwing, stacking and dropping.
- Keep out of wet and rainy environments
- Do not subject to direct sunlight for long periods
- The storage temperature must not be lower than -40 °C or higher than +85 °C



4 Installation

The following checks must be performed prior to installing the equipment:

- The equipment must not show signs of damage or obvious modifications
- The IP protection class of the equipment must correspond with the usage and environmental conditions
- An operator zone definition must be available
- Check whether the equipment category corresponds with the specified zones
- With intrinsically safe systems ("i") the "associated operating materials" (barrier) must always be installed outside the potentially explosive area.
- The labelling of the product must point out that important explosion protection characteristics must be complied with during use.
 - G = Gas, D= Dust
 - Equipment Protection Level EPL / zone area
 - Parameters:
 - ✓ Temperature class (T1...T6)
 - ✓ Explosion group (A, B, C)



Additional information for use in areas where there is a risk of dust explosion:

- The details of the maximum surface temperature are valid only for a dust allowance of a maximum of 5 mm. At higher dust deposits must be reduced with the surface temperature.
 - Determining the maximum permissible surface temperature
 - Dust cloud with ignition temperature $-T_{CL} : T_{max1} = 2/3 T_{CL}$
 - Dust layers with glow temperature $-T_{5mm} : T_{max2} = T_{5mm} - 75^{\circ}C$The smaller value of both must be considered for the maximum permitted surface temperature. To prevent from dangerous temperature rises dust deposits should be avoided (appropriate mounting position, use of protection covers, regular cleaning..)
- For the installation procedure it is necessary to take care that no electrostatic charging will be done (no high volume flow, cleaning only with damp cloth,...)

The following standards and directives are useful:

- EN 1127-1: Explosion protection – basic concepts and methodology
Standards for areas with risk of gas or dust explosion (“G”, “D”):
- EN 60079-10: Classification of potentially explosive areas
- EN 60079-14: Electrical installations in potentially explosive areas
- EN 60079-17: Inspection and maintenance
- EN 60079-25: Intrinsically safe systems



4.1 Installation

Choose the installation location from the following aspects;

- Ease of access for installation, connection and operation
- Protection from direct effects of the weather, such as rain and sun
- The IP protection class of the equipment must suit the ambient conditions
- In order to prevent dangerous temperature increases on the surface of the equipment, dust deposits must be avoided (installation location, protective cover, cleaning measures etc.)
- Switching pressure specifications apply to vertical installation which is also the recommended position with pressure-pipe connections pointing downwards. If the switches are installed horizontally with AMP connection terminals uppermost, the switching values are approx. 20 Pa higher.



4.2 Connection

4.2.1 Pressure connections

2 plastic pipe connection pieces (6 mm)

- **P1 +:** for connection to higher pressure
- **P2 -:** for connection to lower pressure



4.2.2 Electrical connections

- When work is being performed such as installation, making electrical connection, making repairs or opening the housing, it must be ensured that
 - *No electrical voltage* is present
 - *Unintentional activation* is not possible
- Proceed as follows in potentially explosive areas:
 - Check whether the equipment category corresponds with the specified zones
 - *No potentially explosive atmosphere* is present
 - A release for work must have been issued by the operator
 - Adherence to the applicable regulations and documentation for the equipment
- Special notes for intrinsically safe (“i”) systems:
 - Each intrinsically safe operating material must have an associated operating material inserted before it, outside of the potentially explosive zone.
 - *Separate cable routing* for intrinsically safe and non-intrinsically safe power circuits.
 - For operating voltages of *less than 42V AC or 60V AC*: Intrinsically safe and non-intrinsically safe power circuits can be *routed together* in this case. This *only* applies to safety barrier *with galvanic separation*.
 - Separation of *intrinsically safe/non-intrinsically safe* connecting parts: at least 50mm (tight string length)
 - Distance between *different intrinsically safe power circuits*: at least 6mm
 - Distances between non-insulated *conductive parts* leading to connecting parts: air gap of at least 3mm (housing-terminals-conductor tracks, earth etc.)



➤ **Power supply**

- Each intrinsically safe operating material must have an associated operating material inserted before it, outside of the potentially explosive zone: 
- ✓ Pay attention to maximum characteristics (U, I, P, L, C):
Compare the information on the specification plate of the appropriate equipment and the pressure switch 930..EX

➤ **Select connecting cables**

The following points must be observed when selecting the cable:

- Select cable material that complies with the local resistance requirements (mechanical, chemical) 
- The outer diameter may be from 5 to 9 mm
- Cable cross-section in accordance with electrical power and data sheet

The following points must be observed when selecting cables for intrinsically safe power circuits:

- *Diameter* of individual conductors: *greater than 0.1mm*
- *Insulation strength* of the individual wires: *greater than 0.2 mm*
- *Test voltage* for intrinsically safe cables:
- between wires, shield and earth: *500V AC*
- *Shield*: The shield area must be *60%* of the surface coverage or twisting
- *Labelling* of intrinsically safe power circuits: *colour preferably light blue*
- L and C cable characteristics must be available ($C=110nF/km$; $L=1 mH/km$)

➤ **Cable routing**

- If there is a risk of mechanical damage, the cable must be provided with additional protection (protective tube etc.)
- The cable diameter must be complied with in order to provide a tight connection in the cable lead-in.
- The screwed cable connection and the screws of the housing cover must be tightened in order to comply with the IP protection class. Over-tightening damages the housing.

➤ **Connecting the cable**

- Please ensure that the cables that are being connected are not live. otherwise there is a risk of igniting a potentially explosive atmosphere 

➤ **Attach the shield**

- Attach shield at one end (in non-potentially explosive area)
- Attach braiding of shield to earth potential over a wide area.
- No potential equalisation current must be flowing between potentially explosive areas and non-potentially explosive areas. Separation using a capacitor is permitted in this case for EMC purposes (total max. 10 nF). 

➤ **Earthing**

- The external earthing terminal on the housing must be connected to the potential equalisation of the potentially explosive area with low resistance 
(removal of electrostatic charge between 0.2-1 MOhms is considered to be earthing)
- No potential equalisation current must be flowing between potentially explosive areas and non-potentially explosive areas
- Minimum cross-section: 2 x 1.5 mm² or 1 x 4 mm²
- Intrinsically safe power circuits: Housings made from *metal do not need to be earthed*. (If this is necessary anyway – functional earthing, earthing in one location only...)

➤ **Documentation**

- Operating instructions, conformity declaration, EU-Type Examination Certificate
- System and zonal plan
- Proof of adherence to explosion protection regulations (see Appendix 9.34)
 - ✓ Equipment selection: category, Equipment Protection Level EPL, temperature class, explosion group, ...
 - ✓ Proof of adherence to intrinsic safety requirements



5 Start-up

Before voltage is applied to the equipment the following checks must be performed:

- Check that screws are firmly seated in
 - Connecting terminals, protective earth conductor terminals and potential equalisation terminals
 - Housing cover
- Check
 - The torque of the cable lead-in
 - The tightness of the seal provided by the cable lead-in
- Check whether the equipment is ready for operation
 - The parameterisation for this application must have been performed
 - All interfaces such as inputs and outputs for control purposes must be connected and ready for operation



5.1 Parameterisation

Equipment parameterisation

- Define all application-specific parameters.
- Adjustment of the pressure ranges
 - With this pressure switch the pressure can be adjusted without a pressure gauge using a scaled adjustment knob
 - The switching differential can also be adjusted with a screwdriver by the adjustment screw with the identification “-Δp+”

Type	Adjustment range for trip pressure from to	Switching differential	Tolerance band of
930.80B EX	20 300 Pa	10 Pa	±15 %
930.83 EX	50 500 Pa	20 Pa	±15 %
930.84 EX	30 400 Pa	15 Pa	±15 %
930.85 EX	200 1000 Pa	100 Pa	±15 %
930.86 EX	500 2500 Pa	150 Pa	±15 %
930.87B EX	1000 5000 Pa	250 Pa	±15 %

Note:

Switching pressure specifications apply to vertical installation which is also the recommended position with pressure-pipe connections pointing downwards. If the switches are installed horizontally with AMP connection terminals uppermost, the switching values are approx. 20 Pa higher.

- Once the power supply is applied, the equipment is ready for operation immediately.

6 Maintenance / Service

The equipment can only be guaranteed to operate safely and reliably in the long term if regular inspections and servicing are carried out. These include the following:

For cleaning the devices it is necessary to take care that no electrostatic charging will be done (no high volume flow, cleaning only with damp cloth,...)

An **inspection** includes

- Visual inspection
 - Mechanical damage
 - Non-permitted dust deposits
 - Other irregularities or error messages from the equipment
- Checking of components (wearing parts) whose functionality or purpose changes and affects the operation of the equipment
- Documentation of what was done by whom, and when

Maintenance includes

- Functionality checking
 - Operating statuses such as alarms etc.
- Checking calibration values (= calibration)
 - Triggering of alarms by known process parameters (test pressure etc.)
- Correction of calibration values (= calibration) must be carried out in the factory
- Documentation of what was done by whom, and when

6.1 Time intervals



Inspection:

The condition of the equipment must be checked at regular intervals. The time interval is extremely dependent on the local situation and the degree of use, and must therefore be adapted to requirements. Extremely short time intervals can be specified such as once per day, every new shift etc.

- Defined by the operator in accordance with local requirements

Maintenance

- The interval from the applicable usage regulations must be taken into consideration
- As a manufacturer we recommend a maximum interval of 1 year

6.2 Troubleshooting

A list of possible faults (fault indications) can be found in the table below.

The table contains an explanation of how to detect faults.

A list of possible causes and remedial measures also follows.



Fault indication	Possible cause	Measures
Contact won't switch	Defective diaphragm	Replace pressure switch
	Spring defective	
	Pressure connection blocked	
	Pressure outside working range	

7 Repairs

The following points must be noted before carrying out any work whatsoever on the equipment:

- When work is being performed such as installation, making electrical connections or opening the housing, it must be ensured that
 - *No electrical voltage* is present
 - *Unintentional activation* is not possible
- Repairs must only be carried out by the manufacturer
- The following must be observed in potentially explosive areas:
 - *No potentially explosive atmosphere* is present
 - A release for work must have been issued by the operator
 - The applicable regulations and all documentation for this equipment must be adhered to
 - Only original spare parts from the manufacturer must be used
 - The spare parts must comply with the required equipment category
 - Interventions that influence explosion protection must only be carried out by *experts*
A prerequisite is adequate *qualification* (“capable person”) with regard to *explosion protection* and the use of the *equipment*



8 Dismantling

The following points must be noted before carrying out any work whatsoever on the equipment:

- Ensure that the equipment may be removed and that appropriate replacement measures have been taken.
All of the instructions in chapter-7“Repairs” must be followed.
- Exposed cable (ends) must be marked, and it must be ensured that
 - *No electrical voltage* is present
 - *Unintentional activation* is not possible



8.1 Disposal

The equipment is made from recyclable materials and is designed to make the housing and the electronics easy to separate. Please ensure that all parts are disposed of in accordance with legal regulations.

Please contact us if you cannot dispose of the equipment properly.



9 Appendix

9.1 Technical data and dimensioned drawing

Temperature ranges

Ambient temperature:

- from -20 °C to +85 °C

Medium temperature:

- up to +85 °C

Storage temperature:

- from -40 °C to +85 °C

Diaphragm material

Silicone; others upon request.

Electrical rating

Values indicated for resistive load

- for Gas 2G : 60 mA/30 VDC oder 100 mA/24 VDC
- for Dust 2D: 30V; 60mA ; 0.6W

Electrical connection

- Cable conduit M20x1.5 or cap nut conduit with cable strain relief
- AMP flat plug 6.3 mm x 0.8 mm in accordance with DIN 46244 or push-on screw terminals
- Arrangement of contacts

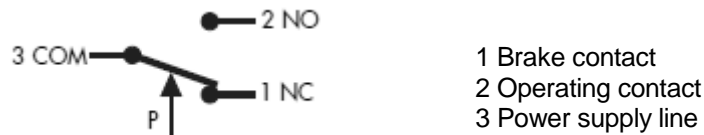

Protection category

- IP 54 (with Cover)

Weight

- 150 g

Certifications

CE conformity in according with ATEX-directive 2014/34/EU.

EU-Type Examination Certificate by the specified EXAM body (ID 0158) with the following ATEX labelling:

- 2G Ex ia IIB T4 Gb
- 2D Ex ia IIIB T135°C Db

Characteristics:

- 2G : 60 mA/30 VDC oder 100 mA/24 VDC
- 2D : 30V; 60mA ; 0.6W
- $L_i = 0$ mH; $C_i = 0$ nF

Life

Minimum 10^6 cycles.

Housing materials

- Switch body made of PC/ABS
- Cover made of PC/ABS

Types / Pressure ranges

Type	Adjustment range for trip pressure from to	Switching differential	Tolerance band of
930.80B EX	20 300 Pa	10 Pa	±15 %
930.83 EX	50 500 Pa	20 Pa	±15 %
930.84 EX	30 400 Pa	15 Pa	±15 %
930.85 EX	200 1000 Pa	100 Pa	±15 %
930.86 EX	500 2500 Pa	150 Pa	±15 %
930.87B EX	1000 5000 Pa	250 Pa	±15 %

Note:

Switching pressure specifications apply to vertical installation which is also the recommended position with pressure-pipe connections pointing downwards. If the switches are installed horizontally with AMP connection terminals uppermost, the switching values are approx. 20 Pa higher.

Pressure connections:

- 2 plastic pipe connection pieces
- external diameter: 6.0 mm

Maximum operating pressure:

- 10 kPa for all pressure ranges

Mounting position

- Switching pressure specifications apply to vertical installation which is also the recommended position with pressure-pipe connections pointing downwards. If the switches are installed horizontally with AMP connection terminals uppermost, the switching values are approx. 20 Pa higher.

Accessories

- Various mounting brackets (see Chapter 9.2)
 - ✓ Metal mounting bracket S-shaped
 - ✓ Metal mounting bracket L-shaped
 - ✓ Snap-on plastic bracket S-shaped
 - ✓ Snap-on plastic bracket L-shaped
- Various connection kits (see Chapter 9.2)
 - ✓ Plastic tube for Climaset®
 - ✓ Angled metal pipe for Climaset®
 - ✓ Rubber grommet for Climaset®
 - ✓ Roll with 100 m PVC hose
- Various cable conduits (see Chapter 9.2)
 - ✓ Cap nut conduit including sealing and counter screw
 - ✓ M20x1.5 cable conduit including sealing and counter screw
 - ✓ NPT1/2" cable conduit without counter parts

9.2 Dimensioned drawings and accessories

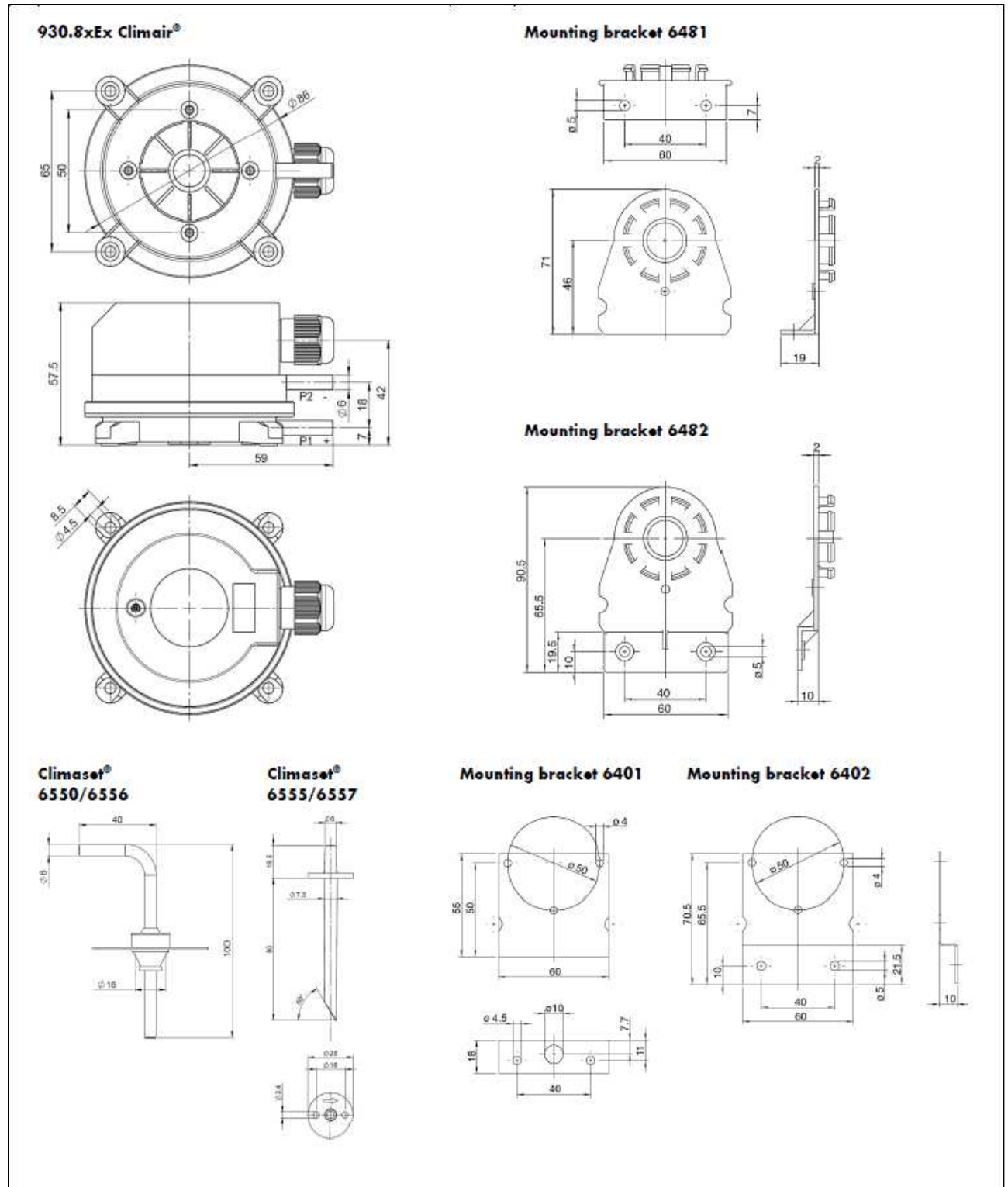



9.3 Declaration of Conformity

EU-Konformitätserklärung EU-Declaration of Conformity



Beck Sensortechnik GmbH
Ferdinand-Steinbeis-Str. 4
71144 Steinbeinbronn
Germany

entsprechend der Explosionschutzrichtlinie 2014/34/EU:

Geräte und Schutzsysteme zur bestimmungsgemäßen Verwendung in explosionsgefährdeten Bereichen
in accordance with ATEX-Directive 2014/34/EU:

Equipment and protective systems intended for use in potentially explosive atmospheres

Name des Herstellers: Beck Sensortechnik GmbH
Name of manufacturer:

Anschrift des Herstellers: Ferdinand-Steinbeis-Str 4, 71144 Steinbeinbronn, Germany
Manufacturer's address:

Produktbezeichnung: Differenzdruckwächter für gasförmige Medien
Product description: Differential Pressure Switch for gaseous media

Modell: Baureihe 930...EX
Model: series 930... EX

Zur Beurteilung der Erzeugnisse hinsichtlich der Richtlinie wurden benannte Stellen miteinbezogen. Für die Verwendung in explosionsgefährdeten Bereichen wurde folgende EG-Baumusterprüfbescheinigung von der notifizierten Stelle mit der Kennnummer-0158 ausgestellt:

The product has been assessed and tested by a notified body. For the application in explosive atmospheres the notified body with identification number -0158 certified this in the EC type examination certificate

BVS 06 ATEX E 141 X und Nachträge 1,2,3,4

0158: DEKRA Testing and Certification GmbH Dinnendahlstrasse 9 D-44809 Bochum

Die grundlegenden Sicherheits- und Gesundheitsanforderungen werden erfüllt durch Übereinstimmung mit:
The essential health and safety requirements are met in conformity with:

EN IEC 60079-0 :2018 Allgemeine Bestimmungen
General requirements
EN 60079-11:2012 Eigensicherheit „I“
Intrinsic safety „I“

Das Produkt wird unter einem Qualitätssicherungssystem -Produktion (Anhang IV der Richtlinie) hergestellt. Dies ist durch die notifizierte Stelle der Kennnummer -0123 anerkannt worden:

The product is manufactured under the modul-product quality assurance (Annex IV of the directive). This was certified by the notified body with the identification number -0123:

TPS 21 ATEX Q 029084 007

0123: TÜV SÜD Product Service GmbH Ridlerstraße 65 D-80339 München

Kennzeichnung des Geräts
Marking of the product



II 2G Ex Ia IIB T4 Gb
II 2D Ex ia IIB T135°C Db

Zusätzliche Informationen:
Additional information:

Diese Erklärung bescheinigt die Übereinstimmung mit den genannten Richtlinien, beinhaltet jedoch keine Zusicherung von Eigenschaften. Die Bedienungsanleitung und Sicherheitshinweise der mitgelieferten Produktdokumentation sind zu beachten.
This declaration confirms only the accordance with the above mentioned directive and do not cover any other characteristics. The manual and security advice of the product has to be kept in mind.

Steinbeinbronn, im September 2021

(Hans-Peter Funk)
Geschäftsführer-Marketing & Vertrieb
Managing director

(Ralph Weigl)
Explosionsschutzbeauftragter
Authorised ATEX-representative



9.4 EU-Type Examination Certificate

Note: More documentation for EU-Type Examination Certificate you can download from our website.



Translation

1 **EU-Type Examination Certificate**
Supplement 4
Change to Directive 2014/34/EU

2 **Equipment intended for use in potentially explosive atmospheres**
Directive 2014/34/EU

3 EU-Type Examination Certificate Number: **BVS 06 ATEX E 141 X**

4 Product: **Pressure sensor types 901***EX and 930***EX**

5 Manufacturer: **Beck Sensortechnik GmbH**

6 Address: **Ferdinand-Steinbeis-Straße 4, 71144 Steinenbronn, Germany**

7 This supplementary certificate extends EC-Type Examination Certificate No. BVS 06 ATEX E 141 X to apply to products designed and constructed in accordance with the specification set out in the appendix of the said certificate but having any acceptable variations specified in the appendix to this certificate and the documents referred to therein.

8 DEKRA Testing and Certification GmbH, Notified Body number 0158, in accordance with Article 17 of Directive 2014/34/EU of the European Parliament and of the Council, dated 26 February 2014, certifies that this product has been found to comply with the Essential Health and Safety Requirements relating to the design and construction of products intended for use in potentially explosive atmospheres given in Annex II to the Directive.
The examination and test results are recorded in the confidential Report No. BVS PP 06.2129 EU.

9 The Essential Health and Safety Requirements are assured in consideration of:

EN IEC 60079-0:2018 General requirements
EN 60079-11:2012 Intrinsic Safety "I"

10 If the sign "X" is placed after the certificate number, it indicates that the product is subject to the Special Conditions for Use specified in the appendix to this certificate.

11 This EU-Type Examination Certificate relates only to the design and construction of the specified product. Further requirements of the Directive apply to the manufacturing process and supply of this product. These are not covered by this certificate.

12 The marking of the product shall include the following:

	for type 901 ***EX	for type 930 ***EX
	II 2G Ex ia IIC T4 Gb	II 2G Ex ia IIB T4 Gb
	II 2D Ex ia IIIB T135°C Db	II 2D Ex ia IIIB T135°C Db

DEKRA Testing and Certification GmbH
Bochum, 23.09.2021

Signed: Jörg-Timm Kilisch

Managing Director



Page 1 of 3 of BVS 06 ATEX E 141 X / N4 – Jobnumber 342332100
This certificate may only be reproduced in its entirety and without any change.
DEKRA Testing and Certification GmbH, Handwerkstr. 15, 70565 Stuttgart, Germany
Certification body: Dinnendahlstr. 9, 44809 Bochum, Germany
Phone +49.234.3696-400, Fax +49.234.3696-401, e-mail DTC-Certification-body@dekra.com



13 **Appendix**
14 **EU-Type Examination Certificate**

**BVS 06 ATEX E 141 X
Supplement 4**

15 **Product description**

15.1 **Subject and type**

Pressure sensor types 901***EX and 930***EX

Numbers are inserted instead of *** in the complete designation to indicate different versions (pressure connection, pressure range, mechanical design); these variants have no influence on the explosion protection.

15.2 **Description**

With this supplement the certificate is changed to Directive 2014/34/EU.
(Annotation: In accordance with Article 41 of Directive 2014/34/EU, EC-Type Examination Certificates referring to 94/9/EC that were in existence prior to the date of application of 2014/34/EU (20 April 2016) may be referenced as if they were issued in accordance with Directive 2014/34/EU. Supplementary Certificates to such EC-Type Examination Certificates, and new issues of such certificates, may continue to bear the original certificate number issued prior to 20 April 2016.)

Subject of the supplement:

- Change to Directive 2014/34/EU
- Update of standards
- Marking adaption for type 901***EX
- New company name
- Change of type plate
- Alternative labelling method of the marking
- Modification of enclosure for type 930***EX
- alternative collar for type 901***EX

Description of Product

The pressure sensor is used as simple electrical equipment for pressure monitoring and output of a switching signal. The pressure sensor can be used in areas that require Categories 2G and 2D equipment.

15.3 **Parameters**

15.3.1 For applications in category 2G:

Switching voltage	U_i	DC	30 / 24	V
Switching current	I_i		60 / 100	mA

15.3.2 For applications in category 2D

Switching voltage	U_i	DC	30	V
Switching current	I_i		60	mA
Power	P_i		0,6	W
Internal inductance	L_i			negligible
Internal capacitance	C_i			negligible

15.3.3 Ambient temperature range

T_a	-20 °C to +85 °C
-------	------------------



Page 2 of 3 of BVS 06 ATEX E 141 X / N4 – Jobnumber 342332100
This certificate may only be reproduced in its entirety and without any change.

DEKRA Testing and Certification GmbH, Handwerkstr. 15, 70566 Stuttgart, Germany
Certification body: Dinnendahlstr. 9, 44809 Bochum, Germany
Phone +49.234.3696-400, Fax +49.234.3696-401, e-mail DTC-Certification-body@dekra.com



16 **Report Number**

BVS PP 06.2129 EU, as of „Datum des Prüfprotokolls“

17 **Special Conditions for Use**

- 7.1.1 The danger of ignition due to propagating brush discharges must be avoided by mounting the equipment in areas without intensive charging mechanism.
- 7.1.2 For types 901**EX, a maximum capacitance of 6.4 pF was measured at the non-grounded collar. Therefore, electrostatic charges in the area of Group IIC must be avoided.

18 **Essential Health and Safety Requirements**

The Essential Health and Safety Requirements are covered by the standards listed under item 9.

19 **Drawings and Documents**

Drawings and documents are listed in the confidential report.

We confirm the correctness of the translation from the German original.
In the case of arbitration only the German wording shall be valid and binding.

DEKRA Testing and Certification GmbH
Bochum, 2021-09-23
BVS-Fro/Mu A20210572



Managing Director



Page 3 of 3 of BVS 06 ATEX E 141 X / N4 – Jobnumber 342332100
This certificate may only be reproduced in its entirety and without any change.

DEKRA Testing and Certification GmbH, Handwerkstr. 15, 70565 Stuttgart, Germany
Certification body: Dinnendahlstr. 9, 44809 Bochum, Germany
Phone +49.234.3696-400, Fax +49.234.3696-401, e-mail DTC-Certification-body@dekra.com



9.5 Proof of compliance with explosion protection regulations

Project			
Name		Date	

Requirement		Complies with		Requirement		Complies with	
Application area	II (Gas)	III (Dust)	II (Gas)	Temperature class (Gas)		Temperature class (Gas)	
				T1	<input type="checkbox"/>	T1	400°C
				T2	<input type="checkbox"/>	T1-T2	300°C
Explosion group	A	<input type="checkbox"/>	A	T3	<input type="checkbox"/>	T1-T3	200°C
	B	<input checked="" type="checkbox"/>	A,B,C	T4	<input checked="" type="checkbox"/>	T1-T4	135°C
	C	<input type="checkbox"/>	A,B,C	T5	<input type="checkbox"/>	T1-T5	100°C
				T6	<input type="checkbox"/>	T1-T6	85°C

Requirement		Permitted Equip. Protection Level EPL (G=Gases)	Certified for	Ignition protection class
Zone	2,22	<input checked="" type="checkbox"/>	Gc,Dc	Zone 2/22
	1,21	<input checked="" type="checkbox"/>	Gb,Db	Zone 1,2 /21,22
	0,20	<input type="checkbox"/>	Ga,Da	Ex ia IIB / Ex ia IIIB

CHARACTERISTICS	Intrinsically safe operating materials		Associated operating materials
Designation	Pressure switch	Cable	Switch amplifier
Model	930 ..EX		
Application area	2G	2D	
Ignition protection class	Ex ia ... Gb	Ex ia...Db	
Explosion group	IIB	IIIB	
Temperature class	T4	T135C	
Certification	BVS 06 ATEX E141X		
U _{i,a}	30V		
I _{i,a}	60mA		
P _{i,a}	600mW		
L _{i,a}	0	1mH	
C _{i,a}	0		

Kabelkennwerte: 1 mH/km ; 110 nF/km

	Requirement complied with
Application area	<input type="checkbox"/>
Ignition protection class	<input type="checkbox"/>
Explosion group	<input type="checkbox"/>
Temperature class	<input type="checkbox"/>
Equipment Protection Level EPL/Zone	<input type="checkbox"/>

Proof of intrinsic safety

	Associated operating materials (barriers)	Requirement	Intrinsically safe operating materials (including cable)	Compliant
U		≤	30V	<input type="checkbox"/>
I		≤	60mA	<input type="checkbox"/>
P		≤	600mA	<input type="checkbox"/>
L		≥	1mH (1km cable)	<input type="checkbox"/>
C		≥	0,1µF (1km cable)	<input type="checkbox"/>